



COVE 4-LEGGED METAL BASE CHAIR

COD.OCOVEV01

DESCRIPTION

Multifunctional chair with 4-legged metal base and polypropylene shell

NOTE

Stackable up to 4 pieces

Optional: articulated foot with felt; painted frame for outdoor use (only aluminum); upholstered cushions and seats in B01, B03, C01, C05, W01, P01

Fire retardant version on request (min 300 pieces) 

Personalized painted frame on request (min 50 pieces) 

EN 16139 1° LEVEL 

TECHNICAL INFORMATION

STRUCTURE

Polypropylene shell 8mm; colors white, anthracite, grey, green, blue, red, ochre, beige

LEGS / FRAME / BASE

16X2mm tubes in steel painted in aluminum, white, shadow grey or chrome

DIMENSION

chair
L 590 H 770 D 520

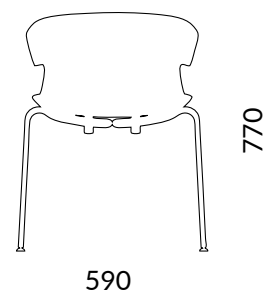

seat
L 500 H 440 D 440

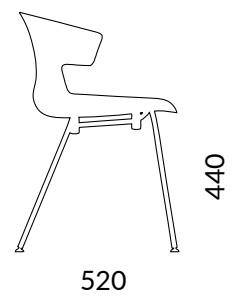

backrest
L 400 H 350

WEIGHT
Net weight a chair: 5 Kg
Gross weight a chair: 6 Kg

PACKAGING
2 disassembled chair per box

VOLUME x collo
M3: 0,17

COD.OCOVEV01

TECHNICAL
DATASHEET

Dimensions in millimeters



COVE METAL SLED BASE CHAIR

COD.OCOVEV02

DESCRIPTION

Multifunctional chair with metal sled base and polypropylene shell

NOTE

Stackable up to 4 pieces

Optional: Linking device; upholstered cushions and seats in B01, B03, C01, C05, W01, P01

Fire retardant version on request (min 300 pieces) 

Personalized painted frame on request (min 50 pieces) 

TECHNICAL INFORMATION

STRUCTURE

Polypropylene shell 8mm; colors white, anthracite, grey, green, blue, red, ochre, beige

LEGS / FRAME / BASE

11mm rods in steel painted in aluminum, white, shadow grey or chrome

DIMENSION

chair
L 590 H 770 D 520

seat
L 500 H 440 D 440

backrest
L 400 H 350

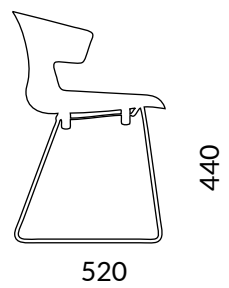
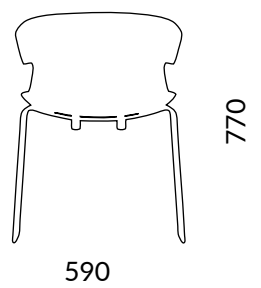

WEIGHT

Net weight a chair: 6 Kg
Gross weight a chair: 7 Kg

PACKAGING

2 disassembled chair per box

VOLUME x package

M3: 0,17

COD.OCOVEV02

TECHNICAL
DATASHEET

Dimensions in millimeters



COVE WOODEN 4 LEG CHAIR

COD.OCOVEV03

DESCRIPTION

Multifunctional chair with solid beech base and polypropylene shell

NOTE

Optional: upholstered seat in B01, B03, C01, C05, W01, P01

Personalized painted frame on request (min 20 pieces) 

TECHNICAL INFORMATION

STRUCTURE

Polypropylene shell 8mm; colors white, anthracite, grey, green, blue, red, ochre, beige

LEGS / FRAME / BASE

Solid beech with natural or wenghè finish. Personalized painted frame on request.

DIMENSION

chair
L 550 H 770 D 520

seat
L 500 H 440 D 440

backrest
L 400 H 350

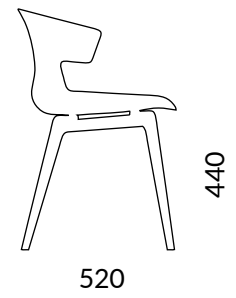
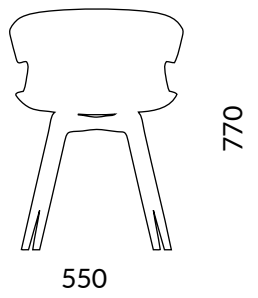

WEIGHT

Net weight a chair: 5 Kg
Gross weight a chair: 6 Kg

PACKAGING

1 package with two shells
1 package with two stems

VOLUME x 2 chairs

M3: 0,26

COD.OCOVEV03

TECHNICAL
DATASHEET

Dimensions in millimeters



COVE CHAIR WITH SWIVEL TRESTLE BASE

COD.OCOVEV04

DESCRIPTION

Multifunctional chair with aluminum base and polypropylene shell

NOTE

Optional: upholstered cushions and seats in B01, B03, C01, C05, W01, P01

Fire retardant version on request (min 300 pieces) 

TECHNICAL INFORMATION

STRUCTURE

Polypropylene shell 8mm; colors white, anthracite, grey, green, blue, red, ochre, beige

LEGS / FRAME / BASE

700mm trestle in die-cast aluminum painted white, aluminum or shadow grey

DIMENSION

chair
L 560 H 780 D 510

seat
L 500 H 440 D 440

backrest
L 400 H 350

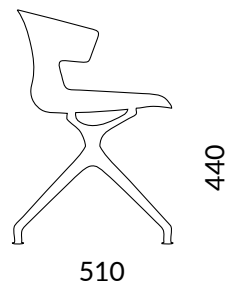
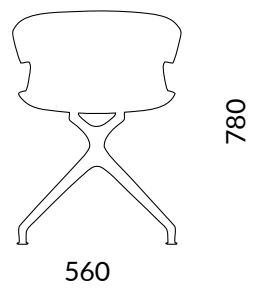

WEIGHT

Net weight a chair: 7 Kg
Gross weight a chair: 10 Kg

PACKAGING

1 package with two shells
1 package with two stems

VOLUME x 2 chairs

M3: 0,25

COD.OCOVEV04

TECHNICAL
DATASHEET

Dimensions in millimeters



COVE UPHOLSTERED 4-LEGGED METAL BASE CHAIR

COD.OCOVEV21

DESCRIPTION

Multifunctional chair with 4-legged metal base and upholstered shell

NOTE

11M fire retardant B01 fabric upholstered shell 

Optional: articulated feet with felt

Personalized painted frame on request (min 50 pieces) 

TECHNICAL INFORMATION

STRUCTURE

Upholstered polypropylene shell 8mm

PADDING Injection molded polyurethane foam

Seat: thickness 20 mm, density 50 Kg/m³

Backrest: thickness 20 mm, density 50 Kg/m³

LEGS / FRAME / BASE

16X2mm tubes in steel painted in aluminum, white, shadow grey or chrome

UPHOLSTERY

categories B01-B03-C01-C05-W01-D02-P01 (SEE FABRIC FOLDER)

DIMENSION

chair
L 590 H 770 D 520

seat
L 490 H 440 D 430

backrest
L 400 H 340

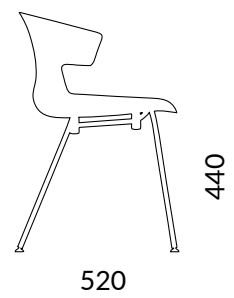
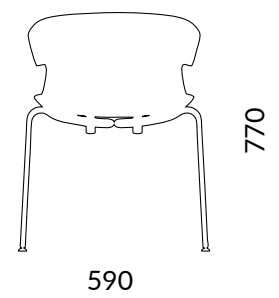

WEIGHT

Net weight a chair: 5,5 Kg
Gross weight a chair: 7,5 Kg

PACKAGING

1 disassembled chair per box

VOLUME x package

M3: 0,17

COD.OCOVEV21

TECHNICAL
DATASHEET

Dimensions in millimeters



COVE UPHOLSTERED METAL SLED BASE CHAIR

COD.OCOVEV22

DESCRIPTION

Multifunctional chair with metal sled base and upholstered shell

NOTE

11M fire retardant B01 fabric upholstered shell 

Optional: linking device

Personalized painted frame on request (min 50 pieces) 

TECHNICAL INFORMATION

STRUCTURE

Upholstered polypropylene shell 8mm

PADDING Injection molded polyurethane foam

Seat: thickness 20 mm, density 50 Kg/m³

Backrest: thickness 20 mm, density 50 Kg/m³

LEGS / FRAME / BASE

11mm steel painted rod in aluminum, white, shadow grey or chrome

UPHOLSTERY

categories B01-B03-C01-C05-W01-D02-P01 (SEE FABRIC FOLDER)

DIMENSION

chair
L 600 H 780 D 510

seat
L 490 H 440 D 430

backrest
L 400 H 340

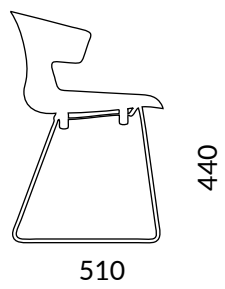
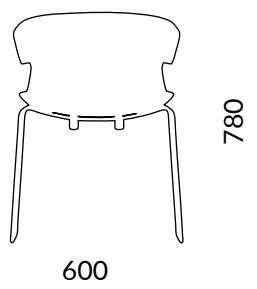

WEIGHT

Net weight a chair: 6,5 Kg
Gross weight a chair: 8,5 Kg

PACKAGING

1 disassembled chair per box

VOLUME x package

M3: 0,17

COD.OCOVEV22

TECHNICAL
DATASHEET

Dimensions in millimeters





COVE UPHOLSTERED WOODEN 4 LEG CHAIR

COD.OCOVEV23

DESCRIPTION

Multifunctional chair with solid beech base and upholstered shell

NOTE

11M fire retardant B01 fabric upholstered shell 
Personalized painted frame on request (min 20 pieces) 

TECHNICAL INFORMATION

STRUCTURE

Polypropylene seat

PADDING Injection molded polyurethane foam

Seat: thickness 20 mm, density 50 Kg/m³

Backrest: thickness 20 mm, density 50 Kg/m³

LEGS / FRAME / BASE

Solid beech with natural or wenghè finish. Personalized painted frame on request.

UPHOLSTERY

categories B01-B03-C01-C05-W01-D02-P01 (SEE FABRIC FOLDER)

DIMENSION

chair
L 550 H 770 D 520

seat
L 490 H 440 D 430

backrest
L 400 H 340

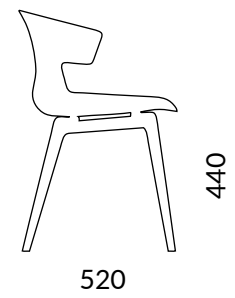
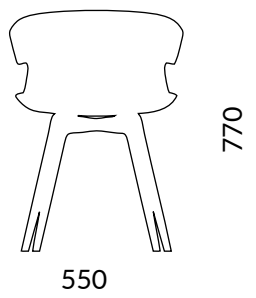

WEIGHT

Net weight a chair: 5,5 Kg
Gross weight a chair: 7,5 Kg

PACKAGING

2 package with two shells
1 package with two stems

VOLUME x 2 chairs

M3: 0,41

COD.OCOVEV23

TECHNICAL
DATASHEET

Dimensions in millimeters



COVE UPHOLSTERED CHAIR WITH SWIVEL TRESTLE BASE

COD.OCOVEV24

DESCRIPTION

Multifunctional chair with aluminum base and upholstered shell

NOTE

11M fire retardant B01 fabric upholstered shell 

TECHNICAL INFORMATION

STRUCTURE

Upholstered polypropylene shell 8mm

PADDING Injection molded polyurethane foam

Seat: thickness 20 mm, density 50 Kg/m³

Backrest: thickness 20 mm, density 50 Kg/m³

LEGS / FRAME / BASE

700mm trestle in die-cast aluminum painted white, aluminum or shadow grey

UPHOLSTERY

categories B01-B03-C01-C05-W01-D02-P01 (SEE FABRIC FOLDER)

DIMENSION

chair
L 560 H 780 D 510

seat
L 490 H 440 D 430

backrest
L 400 H 340

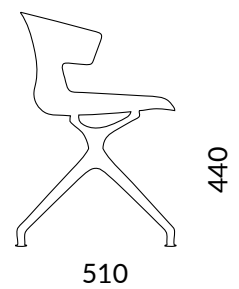
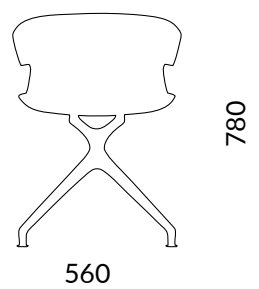

WEIGHT

Net weight a chair: 7 Kg
Gross weight a chair: 10 Kg

PACKAGING

2 package with two shells
1 package with two stems

VOLUME x 2 chairs

M3: 0,39

COD.OCOVEV24

TECHNICAL
DATASHEET

Dimensions in millimeters



COVE 2-PERSON BENCH

COD.OCOVE201

DESCRIPTION

2-person bench

NOTE

Optional: Table for seat substitution; Cushions and chairs upholstered in B01, B03, C01, C05, W01, P01

Fire retardant version on request (min 300 pieces) 

Personalized painted frame on request (min 20 pieces) 

TECHNICAL INFORMATION

STRUCTURE

Polypropylene shell 8mm; colors white, anthracite, grey, green, blue, red, ochre, beige

LEGS / FRAME / BASE

Aluminum painted steel tubes 40X2mm - Aluminum painted steel 80x40x2

DIMENSION

bench
L 1170 H 760 D 510

seat
L 500 H 440 D 440

backrest
L 400 H 350

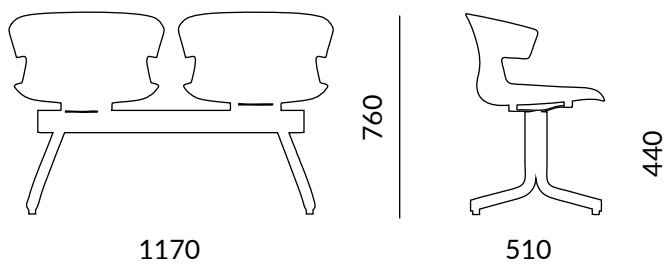

WEIGHT

Net weight: 16 Kg
Gross weight: 19 Kg

PACKAGING

3 packages

VOLUME

M3 box: 0,17

COD.OCOVE201

TECHNICAL
DATASHEET

Dimensions in millimeters

COVE 4-PERSON UPHOLSTERED BENCH

COD.OCOVE403



DESCRIPTION

4-person bench with upholstered seats

NOTE

Optional: Table for seat substitution. Personalized painted frame on request (min 20 pieces) 

TECHNICAL INFORMATION

STRUCTURE

Upholstered polypropylene shell 8mm

PADDING Injection molded polyurethane foam

Seat: thickness 20 mm, density 50 Kg/m³

Backrest: thickness 20 mm, density 50 Kg/m³

LEGS / FRAME / BASE

Aluminum painted steel tubes 40X2mm - Aluminum painted steel 80x40x2

UPHOLSTERY

categories B01-B03-C01-C05-W01-D02-P01 (SEE FABRIC FOLDER)

DIMENSION

bench
L 2390 H 760 D 510

seat
L 490 H 440 D 430

backrest
L 400 H 340

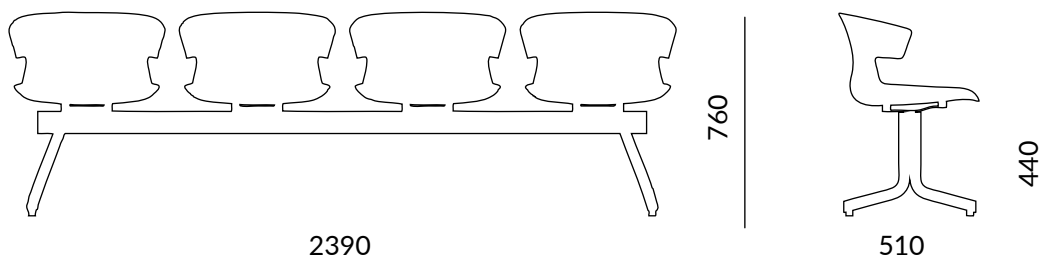

WEIGHT

Net weight: 34 Kg
Gross weight: 39 Kg

PACKAGING

6 packages

VOLUME

M3 box: 0,59

COD.OCOVE403

TECHNICAL
DATASHEET

Dimensions in millimeters



COVE 4-PERSON BENCH

COD.OCOVE401

DESCRIPTION

4-person bench

NOTE

Optional: Table for seat substitution; Cushions and chairs upholstered in B01, B03, C01, C05, W01, P01

Fire retardant version on request (min 300 pieces) 

Personalized painted frame on request. (min 20 pieces) 

TECHNICAL INFORMATION

STRUCTURE

Polypropylene shell 8mm; colors white, anthracite, grey, green, blue, red, ochre, beige

LEGS / FRAME / BASE

Aluminum painted steel tubes 40X2mm - Aluminum painted steel 80x40x2

DIMENSION

bench
L 2390 H 760 D 510

seat
L 500 H 440 D 440

backrest
L 400 H 350

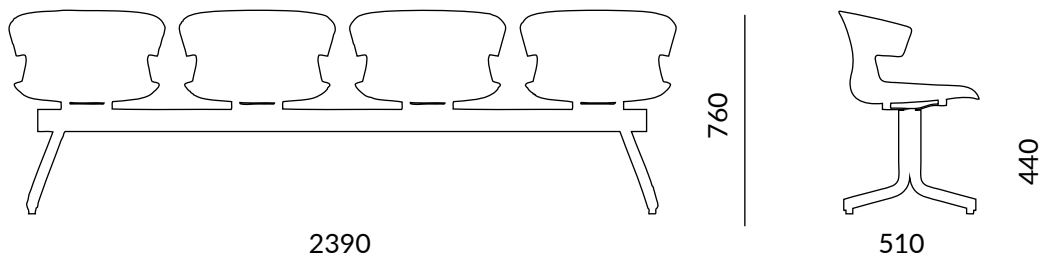

WEIGHT

Net weight: 33 Kg
Gross weight: 38 Kg

PACKAGING

3 packages

VOLUME

M3 box: 0,32

COD.OCOVE401

TECHNICAL
DATASHEET

Dimensions in millimeters



COVE SWIVEL CHAIR 5-STAR BASE WITH WHEELS

COD.OCOVEA01

DESCRIPTION

Multifunctional swivel chair with polypropylene shell and 5-star base

NOTE

Optional: Upholstered cushion - upholstered seat - various types of wheel brakes.

Fire retardant version on request (min 300 pieces) 

TECHNICAL INFORMATION

STRUCTURE

Polypropylene shell 8mm; colors white, anthracite, grey, green, blue, red, ochre, beige

MECHANISM

Gas lift

LEGS / FRAME / BASE

Die-cast aluminum 670mm painted aluminum, white or shadow grey

DIMENSION

chair
L 650 H 740-840 D 650

seat
L 500 H 420-520 D 440

backrest
L 400 H 350

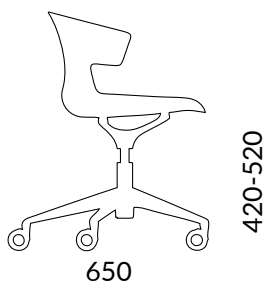
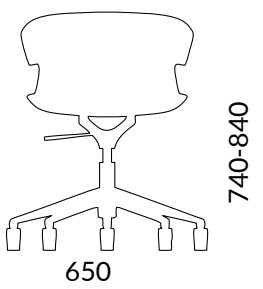

WEIGHT

Net weight a chair: 7 Kg
Gross weight a chair: 9 Kg

PACKAGING

1 disassembled chair per box
L 620 H 650 D 370

VOLUME

M3 box: 0,15

COD.OCOVEA01

TECHNICAL
DATASHEET

Dimensions in millimeters

COVE 2-PERSON UPHOLSTERED BENCH

COD.OCOVE203



DESCRIPTION

2-person bench with upholstered seats

NOTE

Optional: Table for seat substitution

Personalized painted frame on request (min 20 pieces)



TECHNICAL INFORMATION

STRUCTURE

Upholstered polypropylene shell 8mm

PADDING Injection molded polyurethane foam

Seat: thickness 20 mm, density 50 Kg/m³

Backrest: thickness 20 mm, density 50 Kg/m³

LEGS / FRAME / BASE

Aluminum painted steel tubes 40X2mm - Aluminum painted steel 80x40x2

UPHOLSTERY

categories B01-B03-C01-C05-W01-D02-P01 (SEE FABRIC FOLDER)

DIMENSION

bench
L 1170 H 760 D 510

seat
L 490 H 440 D 430

backrest
L 400 H 340

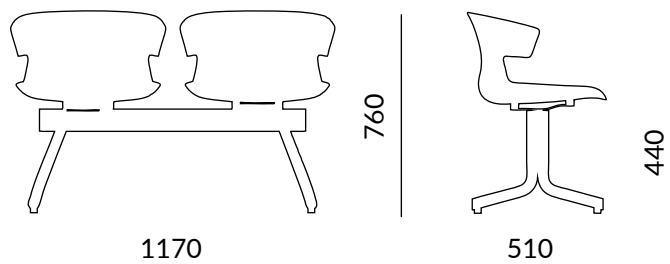

WEIGHT

Net weight: 17 Kg
Gross weight: 20 Kg

PACKAGING

4 packages

VOLUME

M3 box: 0,35

COD.OCOVE203

TECHNICAL
DATASHEET

Dimensions in millimeters



COVE 3-PERSON BENCH

COD.OCOVE301

DESCRIPTION

3-person bench

NOTE

Optional: Table for seat substitution; Cushions and chairs upholstered in B01, B03, C01, C05, W01, P01

Fire retardant version on request (min 300 pieces) 

Personalized painted frame on request (min 20 pieces) 

TECHNICAL INFORMATION

STRUCTURE

Polypropylene shell 8mm; colors white, anthracite, grey, green, blue, red, ochre, beige

LEGS / FRAME / BASE

Aluminum painted steel tubes 40X2mm - Aluminum painted steel 80x40x2

DIMENSION

bench
L 1780 H 760 D 510

seat
L 490 H 440 D 430

backrest
L 400 H 340

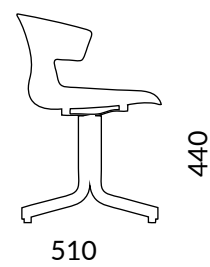
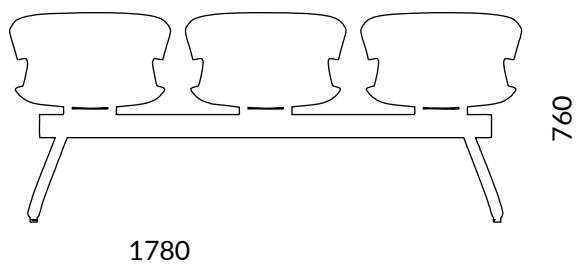

WEIGHT

Net weight: 26 Kg
Gross weight: 31 Kg

PACKAGING

3 packages

VOLUME

M3 box: 0,18

COD.OCOVE301

TECHNICAL
DATASHEET

Dimensions in millimeters



COVE UPHOLSTERED SWIVEL CHAIR 5-STAR BASE WITH WHEELS

COD.OCOVEA21

DESCRIPTION

Multifunctional swivel chair with 5-star base and upholstered shell

NOTE

Optional: Various types of wheel brakes

TECHNICAL INFORMATION

STRUCTURE

Upholstered shell with polypropylene structure 8 mm

MECHANISM

Gas lift

PADDING Injection molded polyurethane foam

Sedile: thickness 20 mm, density 50 Kg/m³

Backrest: thickness 20 mm, density 50 Kg/m³

LEGS / FRAME / BASE

Die-cast aluminum 670 mm painted aluminum, white or shadow grey

UPHOLSTERY

categories B01-B03-C01-C05-W01-D02-P01 (SEE FABRIC FOLDER)

DIMENSION

chair

L 650 H 740-840 D 650

seat

L 490 H 420-520 D 430

backrest

L 400 H 340

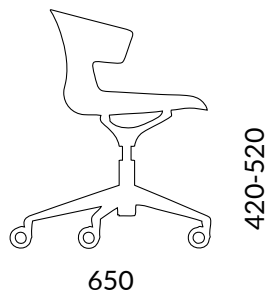
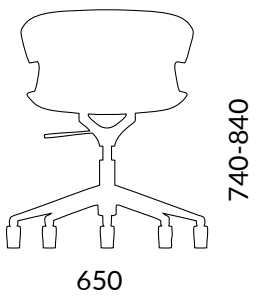

WEIGHT

Net weight a chair: 8 Kg

Gross weight a chair: 10 Kg

PACKAGING

1 disassembled chair per box L

620 H 650 D 480

VOLUME

M3 box: 0,19

COD.OCOVEA21

TECHNICAL
DATASHEET

Dimensions in millimeters

COVE 3-PERSON UPHOLSTERED BENCH

COD.OCOVE303



DESCRIPTION

3-person bench with upholstered seats

NOTE

Optional: Table for seat substitution. Personalized painted frame on request (min 20 pieces) 

TECHNICAL INFORMATION

STRUCTURE

Upholstered polypropylene shell 8mm

PADDING Injection molded polyurethane foam

Seat: thickness 20 mm, density 50 Kg/m³

Backrest: thickness 20 mm, density 50 Kg/m³

LEGS / FRAME / BASE

Aluminum painted steel tubes 40X2mm - Aluminum painted steel 80x40x2

UPHOLSTERY

categories B01-B03-C01-C05-W01-D02-P01 (SEE FABRIC FOLDER)

DIMENSION

bench
L 1780 H 760 D 510

seat
L 490 H 440 D 430

backrest
L 400 H 340

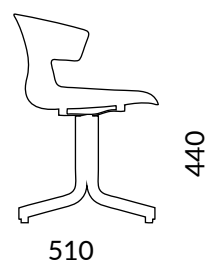
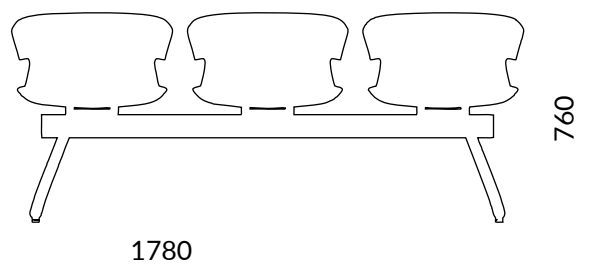

WEIGHT

Net weight: 27 Kg
Gross weight: 32 Kg

PACKAGING

5 packages

VOLUME

M3 box: 0,45

COD.OCOVE303

TECHNICAL
DATASHEET

Dimensions in millimeters



COVE OUTDOOR CHAIR

COD.OCOVE001

DESCRIPTION

Multifunctional chair with metal base and shell

NOTE

Optional: Upholstered seat in synthetic leather B03

Personalized painted frame on request (min 20 pieces) 

Do not expose to rain.

TECHNICAL INFORMATION

STRUCTURE

Steel rod 8mm and 6mm galvanized painted for external use in white or shadow grey

LEGS / FRAME / BASE

Steel frame 12mm with external paint in white or shadow grey

DIMENSION

chair
L 635 H 780 D 520

seat
L 490 H 440 D 430

backrest
L 400 H 350

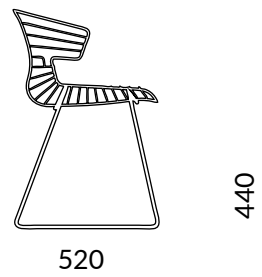
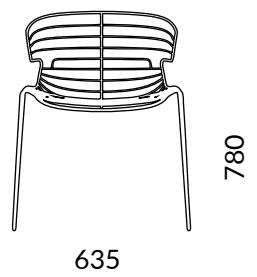

WEIGHT

Net weight a chair: 7 Kg
Gross weight a chair: 8,5 Kg

PACKAGING

2 chairs per package

VOLUME

M3 box: 0,35

COD.OCOVE001

TECHNICAL
DATASHEET

Dimensions in millimeters



COVE 4 LEG H75 STOOL

COD.OCOVES01

DESCRIPTION

Stool with 4-legged metal base and polypropylene shell

NOTE

Stackable up to 2 pieces. Optional: articulated foot with felt; painted frame for outdoor use (only aluminum);

upholstered cushions and seats in B01, B03, C01, C05, W01, P01.

Fire retardant version on request (min 300 pieces) 

Personalized painted frame on request (min 20 pieces) 

TECHNICAL INFORMATION

STRUCTURE

Polypropylene shell 8mm; colors white, anthracite, grey, green, blue, red, ochre, beige

LEGS / FRAME / BASE

16X2mm tubes in chrome steel

DIMENSION

chair
L 670 H 1070 D 575

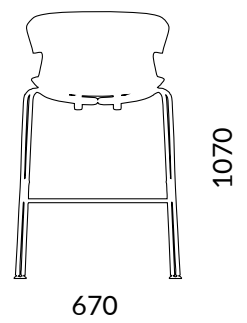

seat
L 500 H 750 D 440

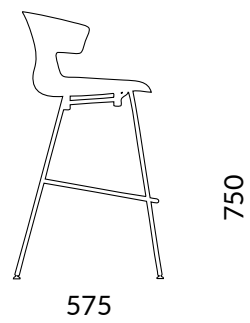

backrest
L 400 H 350

WEIGHT

Net weight a chair: 7,5 Kg
Gross weight a chair: 9 Kg

PACKAGING

2 disassembled chair per box

VOLUME x collo

M3: 0,34

COD.OCOVES01

TECHNICAL
DATASHEET

Dimensions in millimeters



COVE 4 LEG H65 STOOL

COD.OCOVES02

DESCRIPTION

Stool with 4-legged metal base and polypropylene shell

NOTE

Stackable up to 2 pieces. Optional: articulated foot with felt; painted frame for outdoor use (only aluminum); upholstered cushions and seats in B01, B03, C01, C05, W01, P01.

Fire retardant version on request (min 300 pieces) 

Personalized painted frame on request (min 20 pieces) 

TECHNICAL INFORMATION

STRUCTURE

Polypropylene shell 8mm; colors white, anthracite, grey, green, blue, red, ochre, beige

LEGS / FRAME / BASE

16X2mm tubes in chrome steel

DIMENSION

chair
L 670 H 1070 D 575

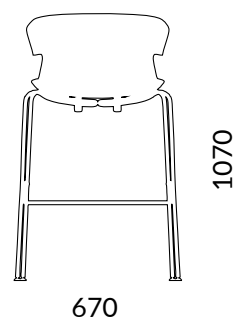

seat
L 500 H 650 D 440



backrest
L 400 H 350

WEIGHT

Net weight a chair: 7 Kg
Gross weight a chair: 8,5 Kg

PACKAGING

2 disassembled chair per box

VOLUME x collo

M3: 0,34

COD.OCOVES02
TECHNICAL
DATASHEET

Dimensions in millimeters



COVE SWIVEL BASE STOOL

COD.OCOVES03

DESCRIPTION

Swivel base stool with adjustable height

NOTE

Optional: upholstered cushions and seats in B01, B03, C01, C05, W01, P01

Fire retardant version on request (min 300 pieces) 

TECHNICAL INFORMATION

STRUCTURE

Polypropylene shell 8mm; colors white, anthracite, grey, green, blue, red, ochre, beige

MECHANISM

MEC01- No mechanism

LEGS / FRAME / BASE

Chrome plated ballast with elevated footrest

DIMENSION

chair
L 560 H 860-1110 D 510

seat
L 500 H 440 D 440

backrest
L 400 H 350

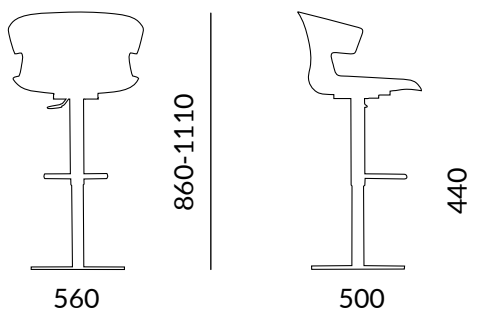

WEIGHT

Net weight a chair: 21 Kg
Gross weight a chair: 24 Kg

PACKAGING

1 assembled chair per package

VOLUME x collo

M3: 0,35

COD.OCOVES03

TECHNICAL
DATASHEET

Dimensions in millimeters



COVE UPHOLSTERED 5-STAR SWIVEL BASE STOOL

COD.OCOVES04

DESCRIPTION

Swivel based adjustable height stool, with adjustable height footrest, polypropylene shell

NOTE

Optional: upholstered cushions and seats in B01, B03, C01, C05, W01, P01

Fire retardant version on request (min 300 pieces) 

TECHNICAL INFORMATION

STRUCTURE

Polypropylene shell 8mm; colors white, anthracite, grey, green, blue, red, ochre, beige

MECHANISM

MEC01- No mechanism

LEGS / FRAME / BASE

Base in alluminio pressofuso d670 verniciata alluminio o bianco; piastra e poggipiedi in tinta

DIMENSION

chair

L 650 H 900-1160 D 650

seat

L 500 H 530-780 D 440

backrest

L 400 H 350

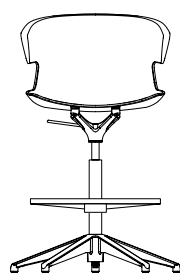

900-1160

650

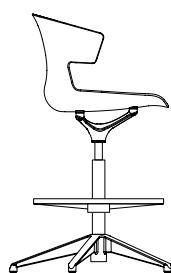

530-780

650

WEIGHT

Net weight a chair: 8 Kg

Gross weight a chair: 10 Kg

PACKAGING

1 disassembled chair per box

VOLUME

M3 box: 0,19

COD.OCOVES04

TECHNICAL
DATASHEET

Dimensions in millimeters



COVE UPHOLSTERED FRAME 4 LEG H75 STOOL

COD.OCOVES21

DESCRIPTION

Stool with 4-legged metal base with upholstered polypropylene shell

NOTE

11M fire retardant B01 fabric upholstered shell 

Optional: articulated foot with felt

Personalized painted frame on request (min 20 pieces) 

TECHNICAL INFORMATION

STRUCTURE

Upholstered polypropylene shell 8mm

PADDING Injection molded polyurethane foam

Seat: thickness 20 mm, density 50 Kg/m³

Backrest: thickness 20 mm, density 50 Kg/m³

LEGS / FRAME / BASE

16X2mm tubes in chrome steel

UPHOLSTERY

categories B01-B03-C01-C05-W01-D02-P01 (SEE FABRIC FOLDER)

DIMENSION

chair
L 670 H 1010 D 575

seat
L 490 H 750 D 430

backrest
L 400 H 340

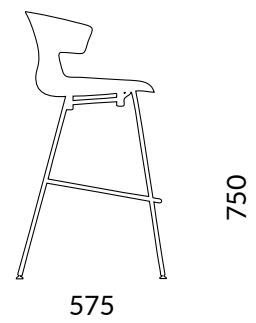
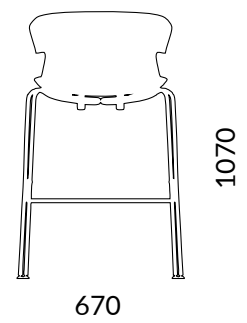

WEIGHT

Net weight a chair: 8 Kg

Gross weight a chair: 11 Kg

PACKAGING

1 x box

L 625 H 680 D 790

VOLUME

M3 box: 0,34

COD.OCOVES21

TECHNICAL
DATASHEET

Dimensions in millimeters



COVE UPHOLSTERED FRAME 4 LEG H65 STOOL

COD.OCOVES22

DESCRIPTION

Stool with 4-legged metal base with upholstered polypropylene shell

NOTE

11M fire retardant B01 fabric upholstered shell 

Optional: articulated foot with felt

Personalized painted frame on request (min 20 pieces) 

TECHNICAL INFORMATION

STRUCTURE

Upholstered polypropylene shell 8mm

PADDING Injection molded polyurethane foam

Seat: thickness 20 mm, density 50 Kg/m³

Backrest: thickness 20 mm, density 50 Kg/m³

LEGS / FRAME / BASE

16X2mm tubes in chrome steel

UPHOLSTERY

categories B01-B03-C01-C05-W01-D02-P01 (SEE FABRIC FOLDER)

DIMENSION

chair
L 670 H 1070 D 575

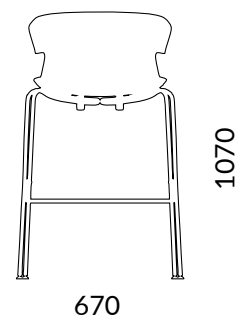

seat
L 490 H 650 D 430



backrest
L 400 H 340

WEIGHT

Net weight a chair: 7,5 Kg
Gross weight a chair: 10,5 Kg

PACKAGING

1 x box
L 625 H 680 D 790

VOLUME

M3 box: 0,34

COD.OCOVES22

TECHNICAL
DATASHEET

Dimensions in millimeters



COVE UPHOLSTERED SWIVEL BASE STOOL

COD.OCOVES23

DESCRIPTION

Swivel base stool with adjustable height

NOTE

11M fire retardant B01 fabric upholstered shell 

TECHNICAL INFORMATION

STRUCTURE

Upholstered polypropylene shell 8mm

MECHANISM

MEC01- No mechanism

PADDING Injection molded polyurethane foam

Seat: thickness 20 mm, density 50 Kg/m³

Backrest: thickness 20 mm, density 50 Kg/m³

LEGS / FRAME / BASE

Chrome plated ballast with elevated footrest

UPHOLSTERY

categoryess B01-B03-C01-C05-W01-D02-P01 (SEE FABRIC FOLDER)

DIMENSION

chair

L 560 H 860-1110 D 510

seat

L 490 H 440 D 430

backrest

L 400 H 340

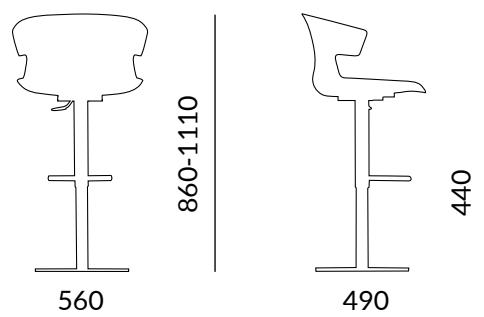

WEIGHT

Net weight a chair: 21,5 Kg
Gross weight a chair: 24,5 Kg

PACKAGING

1 assembled chair per package

VOLUME

M3 package: 0,35

COD.OCOVES23

TECHNICAL
DATASHEET

Dimensions in millimeters



COVE UPHOLSTERED 5-STAR SWIVEL BASE aSTOOL

COD.OCOVES24

DESCRIPTION

Swivel based adjustable height stool, with adjustable height footrest, upholstered shell

NOTE

11M fire retardant B01 fabric upholstered shell 

TECHNICAL INFORMATION

STRUCTURE

Upholstered polypropylene shell 8mm

MECHANISM

MEC01- No mechanism

PADDING Injection molded polyurethane foam

Seat: thickness 20 mm, density 50 Kg/m³

Backrest: thickness 20 mm, density 50 Kg/m³

LEGS / FRAME / BASE

Base in die-cast aluminum 670mm painted aluminum or white; matching plate and footrest

UPHOLSTERY

categoryess B01-B03-C01-C05-W01-D02-P01 (SEE FABRIC FOLDER)

DIMENSION

chair

L 650 H 900-1160 D 650

seat

L 490 H 540-790 D 430

backrest

L 400 H 340

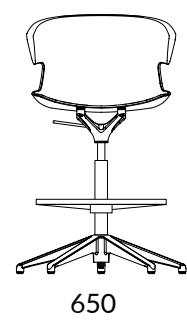

900-1160

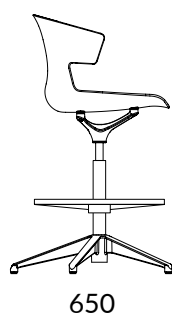

540-790

WEIGHT

Net weight a chair: 9 Kg

Gross weight a chair: 11 Kg

PACKAGING

1 disassembled chair per package

VOLUME

M3 package: 0,19

COD.OCOVES24

TECHNICAL
DATASHEET

Dimensions in millimeters