



# COVE 2-PERSON BENCH

COD.OCOVE201

## DESCRIPTION

2-person bench

## NOTE

Optional: Table for seat substitution; Cushions and chairs upholstered in B01, B03, C01, C05, W01, P01

Fire retardant version on request (min 300 pieces) 

Personalized painted frame on request (min 20 pieces) 

## TECHNICAL INFORMATION

---

### STRUCTURE

Polypropylene shell 8mm; colors white, anthracite, grey, green, blue, red, ochre, beige

### LEGS / FRAME / BASE

Aluminum painted steel tubes 40X2mm - Aluminum painted steel 80x40x2

## DIMENSION

---

**bench**  
L 1170 H 760 D 510

**seat**  
L 500 H 440 D 440

**backrest**  
L 400 H 350

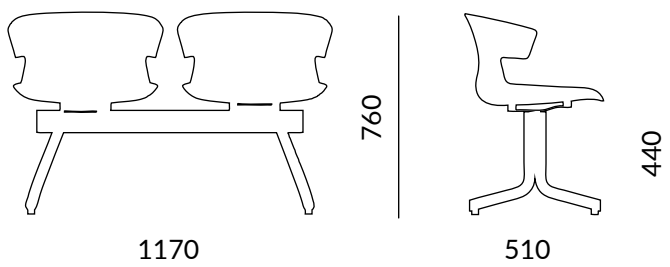

### WEIGHT

Net weight: 16 Kg  
Gross weight: 19 Kg

### PACKAGING

3 packages

### VOLUME

M3 box: 0,17

COD.OCOVE201

TECHNICAL  
DATASHEET

Dimensions in millimeters

# COVE 2-PERSON UPHOLSTERED BENCH

COD.OCOVE203



## DESCRIPTION

2-person bench with upholstered seats

## NOTE

Optional: Table for seat substitution

Personalized painted frame on request (min 20 pieces)



## TECHNICAL INFORMATION

---

### STRUCTURE

Upholstered polypropylene shell 8mm

### PADDING Injection molded polyurethane foam

Seat: thickness 20 mm, density 50 Kg/m<sup>3</sup>

Backrest: thickness 20 mm, density 50 Kg/m<sup>3</sup>

### LEGS / FRAME / BASE

Aluminum painted steel tubes 40X2mm - Aluminum painted steel 80x40x2

### UPHOLSTERY

categories B01-B03-C01-C05-W01-D02-P01 (SEE FABRIC FOLDER)

## DIMENSION

---

**bench**  
L 1170 H 760 D 510

**seat**  
L 490 H 440 D 430

**backrest**  
L 400 H 340

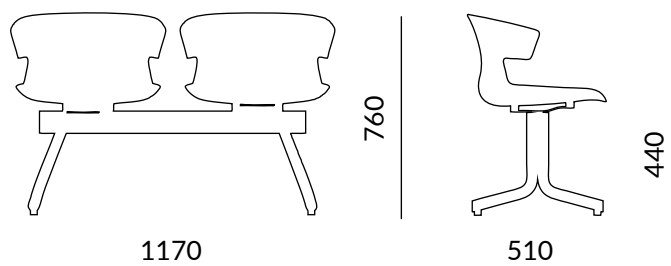

### WEIGHT

Net weight: 17 Kg  
Gross weight: 20 Kg

### PACKAGING

4 packages

### VOLUME

M3 box: 0,35

COD.OCOVE203

TECHNICAL  
DATASHEET

Dimensions in millimeters



# COVE 3-PERSON BENCH

COD.OCOVE301

## DESCRIPTION

3-person bench

## NOTE

Optional: Table for seat substitution; Cushions and chairs upholstered in B01, B03, C01, C05, W01, P01

Fire retardant version on request (min 300 pieces) 

Personalized painted frame on request (min 20 pieces) 

## TECHNICAL INFORMATION

---

### STRUCTURE

Polypropylene shell 8mm; colors white, anthracite, grey, green, blue, red, ochre, beige

### LEGS / FRAME / BASE

Aluminum painted steel tubes 40X2mm - Aluminum painted steel 80x40x2

## DIMENSION

---

**bench**  
L 1780 H 760 D 510

**seat**  
L 490 H 440 D 430

**backrest**  
L 400 H 340

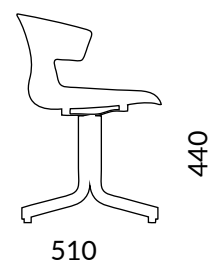
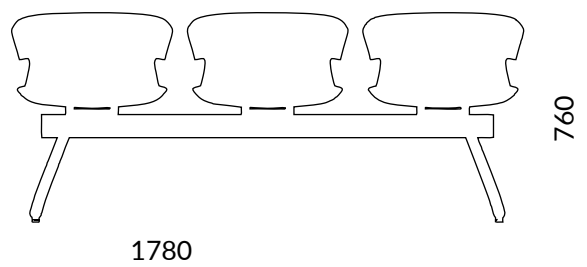

### WEIGHT

Net weight: 26 Kg  
Gross weight: 31 Kg

### PACKAGING

3 packages

### VOLUME

M3 box: 0,18

COD.OCOVE301

TECHNICAL  
DATASHEET

Dimensions in millimeters

# COVE 3-PERSON UPHOLSTERED BENCH

COD.OCOVE303



## DESCRIPTION

3-person bench with upholstered seats

## NOTE

Optional: Table for seat substitution. Personalized painted frame on request (min 20 pieces) 

## TECHNICAL INFORMATION

---

### STRUCTURE

Upholstered polypropylene shell 8mm

### PADDING Injection molded polyurethane foam

Seat: thickness 20 mm, density 50 Kg/m<sup>3</sup>

Backrest: thickness 20 mm, density 50 Kg/m<sup>3</sup>

### LEGS / FRAME / BASE

Aluminum painted steel tubes 40X2mm - Aluminum painted steel 80x40x2

### UPHOLSTERY

categories B01-B03-C01-C05-W01-D02-P01 (SEE FABRIC FOLDER)

## DIMENSION

---

**bench**  
L 1780 H 760 D 510

**seat**  
L 490 H 440 D 430

**backrest**  
L 400 H 340

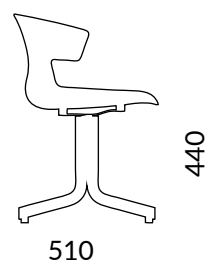
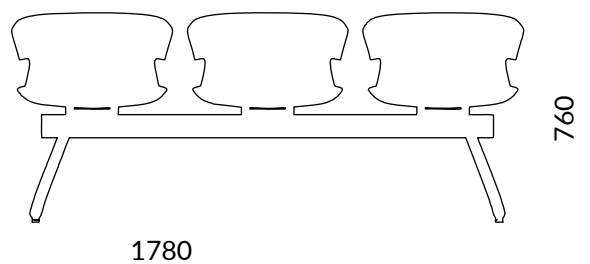

### WEIGHT

Net weight: 27 Kg  
Gross weight: 32 Kg

### PACKAGING

5 packages

### VOLUME

M3 box: 0,45

COD.OCOVE303

TECHNICAL  
DATASHEET

Dimensions in millimeters



# COVE 4-PERSON BENCH

COD.OCOVE401

## DESCRIPTION

4-person bench

## NOTE

Optional: Table for seat substitution; Cushions and chairs upholstered in B01, B03, C01, C05, W01, P01

Fire retardant version on request (min 300 pieces) 

Personalized painted frame on request. (min 20 pieces) 

## TECHNICAL INFORMATION

---

### STRUCTURE

Polypropylene shell 8mm; colors white, anthracite, grey, green, blue, red, ochre, beige

### LEGS / FRAME / BASE

Aluminum painted steel tubes 40X2mm - Aluminum painted steel 80x40x2

## DIMENSION

---

**bench**  
L 2390 H 760 D 510

**seat**  
L 500 H 440 D 440

**backrest**  
L 400 H 350

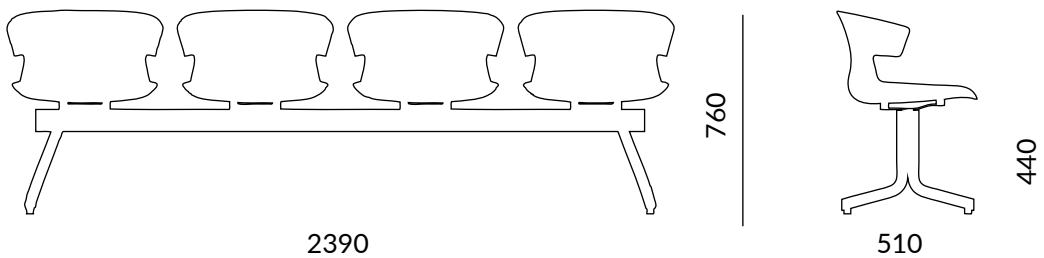

### WEIGHT

Net weight: 33 Kg  
Gross weight: 38 Kg

### PACKAGING

3 packages

### VOLUME

M3 box: 0,32

COD.OCOVE401

TECHNICAL  
DATASHEET

Dimensions in millimeters

# COVE 4-PERSON UPHOLSTERED BENCH

COD.OCOVE403



## DESCRIPTION

4-person bench with upholstered seats

## NOTE

Optional: Table for seat substitution. Personalized painted frame on request (min 20 pieces) 

## TECHNICAL INFORMATION

---

### STRUCTURE

Upholstered polypropylene shell 8mm

### PADDING Injection molded polyurethane foam

Seat: thickness 20 mm, density 50 Kg/m<sup>3</sup>

Backrest: thickness 20 mm, density 50 Kg/m<sup>3</sup>

### LEGS / FRAME / BASE

Aluminum painted steel tubes 40X2mm - Aluminum painted steel 80x40x2

### UPHOLSTERY

categories B01-B03-C01-C05-W01-D02-P01 (SEE FABRIC FOLDER)

## DIMENSION

---

**bench**  
L 2390 H 760 D 510

**seat**  
L 490 H 440 D 430

**backrest**  
L 400 H 340

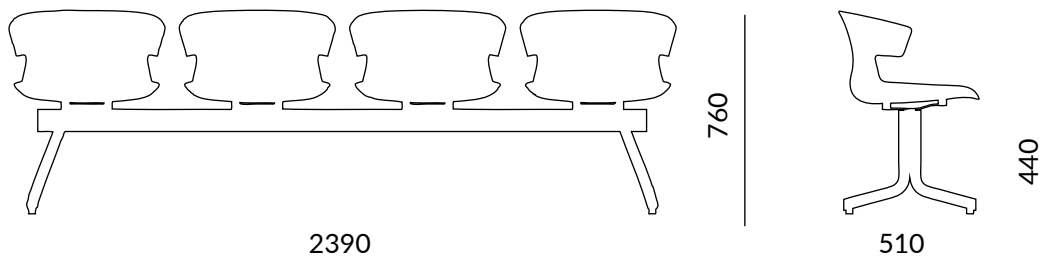

### WEIGHT

Net weight: 34 Kg  
Gross weight: 39 Kg

### PACKAGING

6 packages

### VOLUME

M3 box: 0,59

COD.OCOVE403

TECHNICAL  
DATASHEET

Dimensions in millimeters



# COVE SWIVEL CHAIR 5-STAR BASE WITH WHEELS

COD.OCOVEA01

## DESCRIPTION

Multifunctional swivel chair with polypropylene shell and 5-star base

## NOTE

Optional: Upholstered cushion - upholstered seat - various types of wheel brakes.

Fire retardant version on request (min 300 pieces) 

## TECHNICAL INFORMATION

---

### STRUCTURE

Polypropylene shell 8mm; colors white, anthracite, grey, green, blue, red, ochre, beige

### MECHANISM

Gas lift

### LEGS / FRAME / BASE

Die-cast aluminum 670mm painted aluminum, white or shadow grey

## DIMENSION

---

### chair

L 650 H 740-840 D 650

### seat

L 500 H 420-520 D 440

### backrest

L 400 H 350

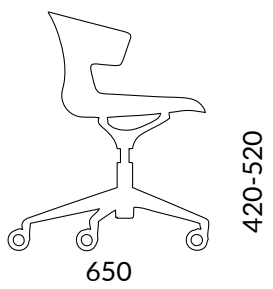
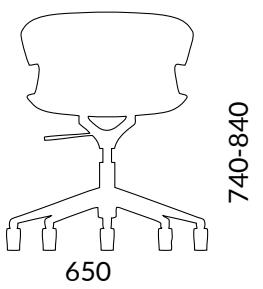

### WEIGHT

Net weight a chair: 7 Kg  
Gross weight a chair: 9 Kg

### PACKAGING

1 disassembled chair per box  
L 620 H 650 D 370

### VOLUME

M3 box: 0,15

COD.OCOVEA01

TECHNICAL  
DATASHEET

Dimensions in millimeters



# COVE UPHOLSTERED SWIVEL CHAIR 5-STAR BASE WITH WHEELS

COD.OCOVEA21

## DESCRIPTION

Multifunctional swivel chair with 5-star base and upholstered shell

## NOTE

Optional: Various types of wheel brakes

## TECHNICAL INFORMATION

---

### STRUCTURE

Upholstered shell with polypropylene structure 8 mm

### MECHANISM

Gas lift

### PADDING Injection molded polyurethane foam

Sedile: thickness 20 mm, density 50 Kg/m<sup>3</sup>

Backrest: thickness 20 mm, density 50 Kg/m<sup>3</sup>

### LEGS / FRAME / BASE

Die-cast aluminum 670 mm painted aluminum, white or shadow grey

### UPHOLSTERY

categories B01-B03-C01-C05-W01-D02-P01 (SEE FABRIC FOLDER)

## DIMENSION

---

### chair

L 650 H 740-840 D 650

### seat

L 490 H 420-520 D 430

### backrest

L 400 H 340

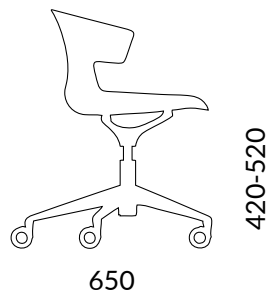
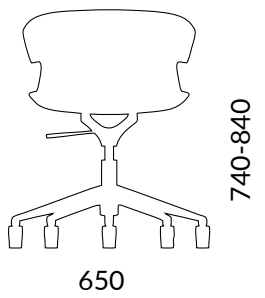

### WEIGHT

Net weight a chair: 8 Kg

Gross weight a chair: 10 Kg

### PACKAGING

1 disassembled chair per box L

620 H 650 D 480

### VOLUME

M3 box: 0,19

COD.OCOVEA21

TECHNICAL  
DATASHEET

Dimensions in millimeters





# COVE OUTDOOR CHAIR

COD.OCOVE001

## DESCRIPTION

Multifunctional chair with metal base and shell

## NOTE

Optional: Upholstered seat in synthetic leather B03

Personalized painted frame on request (min 20 pieces) 

Do not expose to rain.

## TECHNICAL INFORMATION

---

### STRUCTURE

Steel rod 8mm and 6mm galvanized painted for external use in white or shadow grey

### LEGS / FRAME / BASE

Steel frame 12mm with external paint in white or shadow grey

## DIMENSION

---

chair  
L 635 H 780 D 520

seat  
L 490 H 440 D 430

backrest  
L 400 H 350

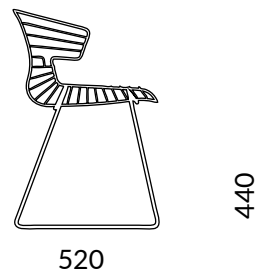
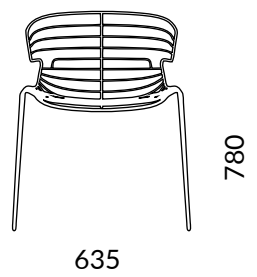

### WEIGHT

Net weight a chair: 7 Kg  
Gross weight a chair: 8,5 Kg

### PACKAGING

2 chairs per package

### VOLUME

M3 box: 0,35

COD.OCOVE001

TECHNICAL  
DATASHEET

Dimensions in millimeters



# COVE 4 LEG H75 STOOL

COD.OCOVES01

## DESCRIPTION

Stool with 4-legged metal base and polypropylene shell

## NOTE

Stackable up to 2 pieces. Optional: articulated foot with felt; painted frame for outdoor use (only aluminum);

upholstered cushions and seats in B01, B03, C01, C05, W01, P01.

Fire retardant version on request (min 300 pieces) 

Personalized painted frame on request (min 20 pieces) 

## TECHNICAL INFORMATION

---

### STRUCTURE

Polypropylene shell 8mm; colors white, anthracite, grey, green, blue, red, ochre, beige

### LEGS / FRAME / BASE

16X2mm tubes in chrome steel

## DIMENSION

---

**chair**  
L 670 H 1070 D 575

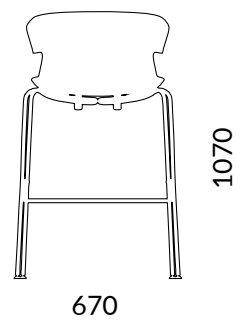

**seat**  
L 500 H 750 D 440

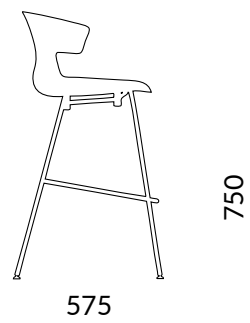

**backrest**  
L 400 H 350

### WEIGHT

Net weight a chair: 7,5 Kg  
Gross weight a chair: 9 Kg

### PACKAGING

2 disassembled chair per box

### VOLUME x collo

M3: 0,34

COD.OCOVES01

TECHNICAL  
DATASHEET

Dimensions in millimeters



# COVE 4 LEG H65 STOOL

COD.OCOVES02

## DESCRIPTION

Stool with 4-legged metal base and polypropylene shell

## NOTE

Stackable up to 2 pieces. Optional: articulated foot with felt; painted frame for outdoor use (only aluminum); upholstered cushions and seats in B01, B03, C01, C05, W01, P01.

Fire retardant version on request (min 300 pieces) 

Personalized painted frame on request (min 20 pieces) 

## TECHNICAL INFORMATION

---

### STRUCTURE

Polypropylene shell 8mm; colors white, anthracite, grey, green, blue, red, ochre, beige

### LEGS / FRAME / BASE

16X2mm tubes in chrome steel

## DIMENSION

---

**chair**  
L 670 H 1070 D 575

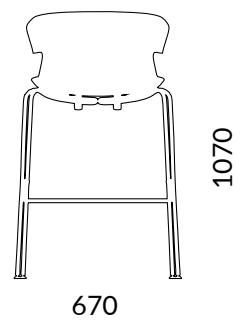

**seat**  
L 500 H 650 D 440



**backrest**  
L 400 H 350

### WEIGHT

Net weight a chair: 7 Kg  
Gross weight a chair: 8,5 Kg

### PACKAGING

2 disassembled chair per box

### VOLUME x collo

M3: 0,34

COD.OCOVES02  
TECHNICAL  
DATASHEET

Dimensions in millimeters



# COVE SWIVEL BASE STOOL

COD.OCOVES03

## DESCRIPTION

Swivel base stool with adjustable height

## NOTE

Optional: upholstered cushions and seats in B01, B03, C01, C05, W01, P01

Fire retardant version on request (min 300 pieces) 

## TECHNICAL INFORMATION

---

### STRUCTURE

Polypropylene shell 8mm; colors white, anthracite, grey, green, blue, red, ochre, beige

### MECHANISM

MEC01- No mechanism

### LEGS / FRAME / BASE

Chrome plated ballast with elevated footrest

## DIMENSION

---

**chair**  
L 560 H 860-1110 D 510

**seat**  
L 500 H 440 D 440

**backrest**  
L 400 H 350

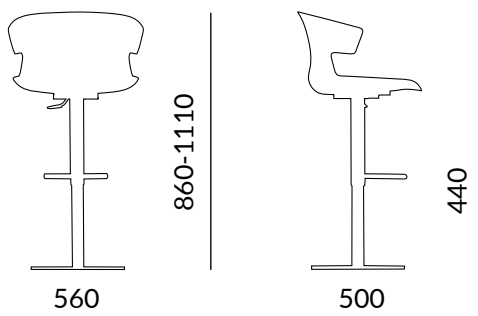

### WEIGHT

Net weight a chair: 21 Kg  
Gross weight a chair: 24 Kg

### PACKAGING

1 assembled chair per package

### VOLUME x collo

M3: 0,35

COD.OCOVES03

TECHNICAL  
DATASHEET

Dimensions in millimeters



# COVE UPHOLSTERED 5-STAR SWIVEL BASE STOOL

COD.OCOVES04

## DESCRIPTION

Swivel based adjustable height stool, with adjustable height footrest, polypropylene shell

## NOTE

Optional: upholstered cushions and seats in B01, B03, C01, C05, W01, P01

Fire retardant version on request (min 300 pieces) 

## TECHNICAL INFORMATION

---

### STRUCTURE

Polypropylene shell 8mm; colors white, anthracite, grey, green, blue, red, ochre, beige

### MECHANISM

MEC01- No mechanism

### LEGS / FRAME / BASE

Base in alluminio pressofuso d670 verniciata alluminio o bianco; piastra e poggipiedi in tinta

## DIMENSION

---

### chair

L 650 H 900-1160 D 650

### seat

L 500 H 530-780 D 440

### backrest

L 400 H 350

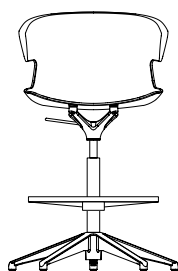

900-1160

650



530-780

650

### WEIGHT

Net weight a chair: 8 Kg

Gross weight a chair: 10 Kg

### PACKAGING

1 disassembled chair per box

### VOLUME

M3 box: 0,19

COD.OCOVES04

TECHNICAL  
DATASHEET

Dimensions in millimeters



# COVE UPHOLSTERED FRAME 4 LEG H75 STOOL

COD.OCOVES21

## DESCRIPTION

Stool with 4-legged metal base with upholstered polypropylene shell

## NOTE

11M fire retardant B01 fabric upholstered shell 

Optional: articulated foot with felt

Personalized painted frame on request (min 20 pieces) 

## TECHNICAL INFORMATION

---

### STRUCTURE

Upholstered polypropylene shell 8mm

### PADDING Injection molded polyurethane foam

Seat: thickness 20 mm, density 50 Kg/m<sup>3</sup>

Backrest: thickness 20 mm, density 50 Kg/m<sup>3</sup>

### LEGS / FRAME / BASE

16X2mm tubes in chrome steel

### UPHOLSTERY

categories B01-B03-C01-C05-W01-D02-P01 (SEE FABRIC FOLDER)

## DIMENSION

---

**chair**  
L 670 H 1010 D 575

**seat**  
L 490 H 750 D 430

**backrest**  
L 400 H 340

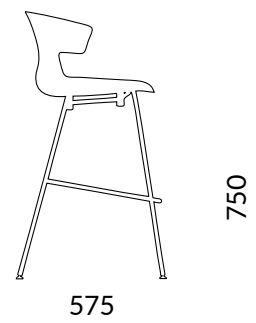
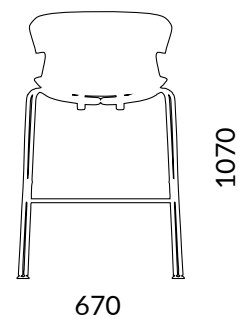

### WEIGHT

Net weight a chair: 8 Kg

Gross weight a chair: 11 Kg

### PACKAGING

1 x box

L 625 H 680 D 790

### VOLUME

M3 box: 0,34

COD.OCOVES21

TECHNICAL  
DATASHEET

Dimensions in millimeters



# COVE UPHOLSTERED FRAME 4 LEG H65 STOOL

COD.OCOVES22

## DESCRIPTION

Stool with 4-legged metal base with upholstered polypropylene shell

## NOTE

11M fire retardant B01 fabric upholstered shell 

Optional: articulated foot with felt

Personalized painted frame on request (min 20 pieces) 

---

## TECHNICAL INFORMATION

### STRUCTURE

Upholstered polypropylene shell 8mm

### PADDING Injection molded polyurethane foam

Seat: thickness 20 mm, density 50 Kg/m<sup>3</sup>

Backrest: thickness 20 mm, density 50 Kg/m<sup>3</sup>

### LEGS / FRAME / BASE

16X2mm tubes in chrome steel

### UPHOLSTERY

categories B01-B03-C01-C05-W01-D02-P01 (SEE FABRIC FOLDER)

---

## DIMENSION

**chair**  
L 670 H 1070 D 575

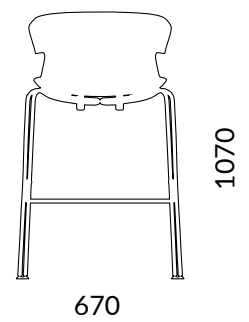

**seat**  
L 490 H 650 D 430



**backrest**  
L 400 H 340

### WEIGHT

Net weight a chair: 7,5 Kg  
Gross weight a chair: 10,5 Kg

### PACKAGING

1 x box  
L 625 H 680 D 790

### VOLUME

M3 box: 0,34

COD.OCOVES22

TECHNICAL  
DATASHEET

Dimensions in millimeters



# COVE UPHOLSTERED SWIVEL BASE STOOL

COD.OCOVES23

## DESCRIPTION

Swivel base stool with adjustable height

## NOTE

11M fire retardant B01 fabric upholstered shell 

## TECHNICAL INFORMATION

---

### STRUCTURE

Upholstered polypropylene shell 8mm

### MECHANISM

MEC01- No mechanism

### PADDING Injection molded polyurethane foam

Seat: thickness 20 mm, density 50 Kg/m<sup>3</sup>

Backrest: thickness 20 mm, density 50 Kg/m<sup>3</sup>

### LEGS / FRAME / BASE

Chrome plated ballast with elevated footrest

### UPHOLSTERY

categoryess B01-B03-C01-C05-W01-D02-P01 (SEE FABRIC FOLDER)

## DIMENSION

---

### chair

L 560 H 860-1110 D 510

### seat

L 490 H 440 D 430

### backrest

L 400 H 340

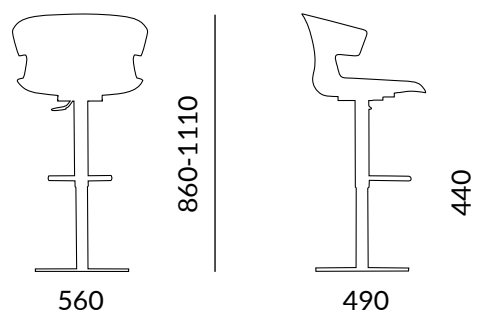

### WEIGHT

Net weight a chair: 21,5 Kg  
Gross weight a chair: 24,5 Kg

### PACKAGING

1 assembled chair per package

### VOLUME

M3 package: 0,35

COD.OCOVES23

TECHNICAL  
DATASHEET

Dimensions in millimeters





# COVE UPHOLSTERED 5-STAR SWIVEL BASE aSTOOL

COD.OCOVES24

## DESCRIPTION

Swivel based adjustable height stool, with adjustable height footrest, upholstered shell

## NOTE

11M fire retardant B01 fabric upholstered shell 

## TECHNICAL INFORMATION

---

### STRUCTURE

Upholstered polypropylene shell 8mm

### MECHANISM

MEC01- No mechanism

### PADDING Injection molded polyurethane foam

Seat: thickness 20 mm, density 50 Kg/m<sup>3</sup>

Backrest: thickness 20 mm, density 50 Kg/m<sup>3</sup>

### LEGS / FRAME / BASE

Base in die-cast aluminum 670mm painted aluminum or white; matching plate and footrest

### UPHOLSTERY

categoryess B01-B03-C01-C05-W01-D02-P01 (SEE FABRIC FOLDER)

## DIMENSION

---

### chair

L 650 H 900-1160 D 650

### seat

L 490 H 540-790 D 430

### backrest

L 400 H 340

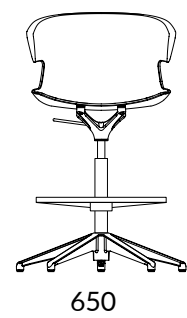

900-1160

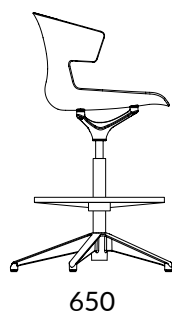

540-790

### WEIGHT

Net weight a chair: 9 Kg

Gross weight a chair: 11 Kg

### PACKAGING

1 disassembled chair per package

### VOLUME

M3 package: 0,19

COD.OCOVES24

TECHNICAL  
DATASHEET

Dimensions in millimeters



# COVE 4-LEGGED METAL BASE CHAIR

COD.OCOVEV01

## DESCRIPTION

Multifunctional chair with 4-legged metal base and polypropylene shell

## NOTE

Stackable up to 4 pieces

Optional: articulated foot with felt; painted frame for outdoor use (only aluminum); upholstered cushions and seats in B01, B03, C01, C05, W01, P01

Fire retardant version on request (min 300 pieces) 

Personalized painted frame on request (min 50 pieces) 

EN 16139 1° LEVEL 

## TECHNICAL INFORMATION

---

### STRUCTURE

Polypropylene shell 8mm; colors white, anthracite, grey, green, blue, red, ochre, beige

### LEGS / FRAME / BASE

16X2mm tubes in steel painted in aluminum, white, shadow grey or chrome

## DIMENSION

---

**chair**  
L 590 H 770 D 520

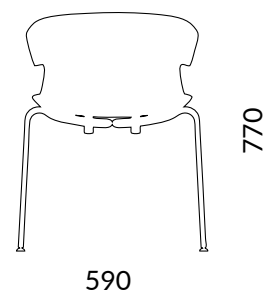

**seat**  
L 500 H 440 D 440

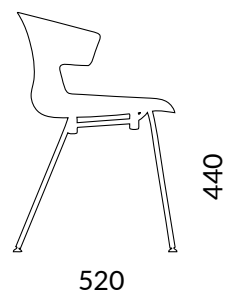

**backrest**  
L 400 H 350

**WEIGHT**  
Net weight a chair: 5 Kg  
Gross weight a chair: 6 Kg

**PACKAGING**  
2 disassembled chair per box

**VOLUME x collo**  
M3: 0,17

COD.OCOVEV01

TECHNICAL  
DATASHEET

Dimensions in millimeters



# COVE METAL SLED BASE CHAIR

COD.OCOVEV02

## DESCRIPTION

Multifunctional chair with metal sled base and polypropylene shell

## NOTE

Stackable up to 4 pieces

Optional: Linking device; upholstered cushions and seats in B01, B03, C01, C05, W01, P01

Fire retardant version on request (min 300 pieces) 

Personalized painted frame on request (min 50 pieces) 

## TECHNICAL INFORMATION

---

### STRUCTURE

Polypropylene shell 8mm; colors white, anthracite, grey, green, blue, red, ochre, beige

### LEGS / FRAME / BASE

11mm rods in steel painted in aluminum, white, shadow grey or chrome

## DIMENSION

---

chair  
L 590 H 770 D 520

seat  
L 500 H 440 D 440

backrest  
L 400 H 350

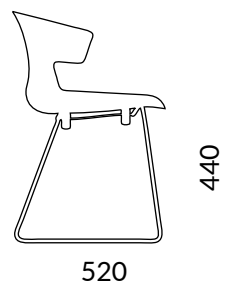
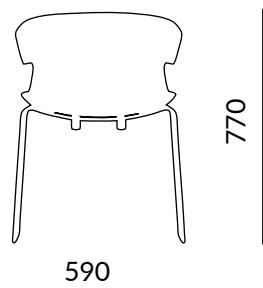

### WEIGHT

Net weight a chair: 6 Kg  
Gross weight a chair: 7 Kg

### PACKAGING

2 disassembled chair per box

### VOLUME x package

M3: 0,17

COD.OCOVEV02

TECHNICAL  
DATASHEET

Dimensions in millimeters



# COVE WOODEN 4 LEG CHAIR

COD.OCOVEV03

## DESCRIPTION

Multifunctional chair with solid beech base and polypropylene shell

## NOTE

Optional: upholstered seat in B01, B03, C01, C05, W01, P01

Personalized painted frame on request (min 20 pieces) 

## TECHNICAL INFORMATION

---

### STRUCTURE

Polypropylene shell 8mm; colors white, anthracite, grey, green, blue, red, ochre, beige

### LEGS / FRAME / BASE

Solid beech with natural or wenghè finish. Personalized painted frame on request.

## DIMENSION

---

**chair**  
L 550 H 770 D 520

**seat**  
L 500 H 440 D 440

**backrest**  
L 400 H 350

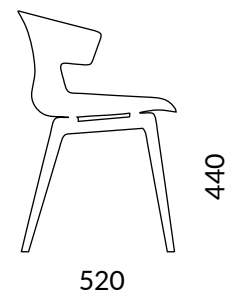
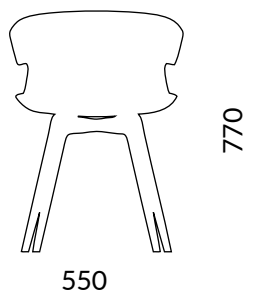

### WEIGHT

Net weight a chair: 5 Kg  
Gross weight a chair: 6 Kg

### PACKAGING

1 package with two shells  
1 package with two stems

### VOLUME x 2 chairs

M3: 0,26

COD.OCOVEV03

TECHNICAL  
DATASHEET

Dimensions in millimeters



# COVE CHAIR WITH SWIVEL TRESTLE BASE

COD.OCOVEV04

## DESCRIPTION

Multifunctional chair with aluminum base and polypropylene shell

## NOTE

Optional: upholstered cushions and seats in B01, B03, C01, C05, W01, P01

Fire retardant version on request (min 300 pieces) 

## TECHNICAL INFORMATION

---

### STRUCTURE

Polypropylene shell 8mm; colors white, anthracite, grey, green, blue, red, ochre, beige

### LEGS / FRAME / BASE

700mm trestle in die-cast aluminum painted white, aluminum or shadow grey

## DIMENSION

---

**chair**  
L 560 H 780 D 510

**seat**  
L 500 H 440 D 440

**backrest**  
L 400 H 350

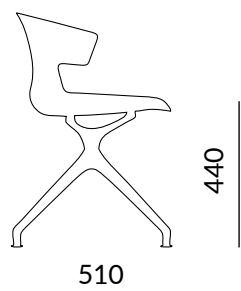
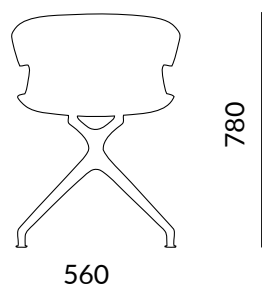

### WEIGHT

Net weight a chair: 7 Kg  
Gross weight a chair: 10 Kg

### PACKAGING

1 package with two shells  
1 package with two stems

### VOLUME x 2 chairs

M3: 0,25

COD.OCOVEV04

TECHNICAL  
DATASHEET

Dimensions in millimeters



# COVE UPHOLSTERED 4-LEGGED METAL BASE CHAIR

COD.OCOVEV21

## DESCRIPTION

Multifunctional chair with 4-legged metal base and upholstered shell

## NOTE

11M fire retardant B01 fabric upholstered shell 

Optional: articulated feet with felt

Personalized painted frame on request (min 50 pieces) 

## TECHNICAL INFORMATION

---

### STRUCTURE

Upholstered polypropylene shell 8mm

### PADDING Injection molded polyurethane foam

Seat: thickness 20 mm, density 50 Kg/m<sup>3</sup>

Backrest: thickness 20 mm, density 50 Kg/m<sup>3</sup>

### LEGS / FRAME / BASE

16X2mm tubes in steel painted in aluminum, white, shadow grey or chrome

### UPHOLSTERY

categories B01-B03-C01-C05-W01-D02-P01 (SEE FABRIC FOLDER)

## DIMENSION

---

**chair**  
L 590 H 770 D 520

**seat**  
L 490 H 440 D 430

**backrest**  
L 400 H 340

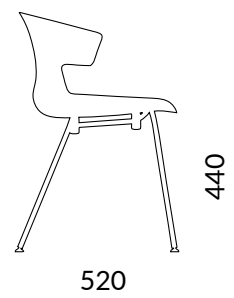
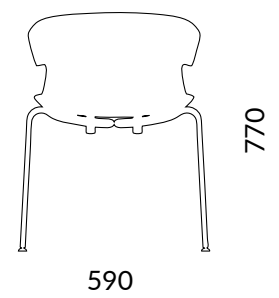

### WEIGHT

Net weight a chair: 5,5 Kg  
Gross weight a chair: 7,5 Kg

### PACKAGING

1 disassembled chair per box

### VOLUME x package

M3: 0,17

COD.OCOVEV21

TECHNICAL  
DATASHEET

Dimensions in millimeters



# COVE UPHOLSTERED METAL SLED BASE CHAIR

COD.OCOVEV22

## DESCRIPTION

Multifunctional chair with metal sled base and upholstered shell

## NOTE

11M fire retardant B01 fabric upholstered shell 

Optional: linking device

Personalized painted frame on request (min 50 pieces) 

## TECHNICAL INFORMATION

---

### STRUCTURE

Upholstered polypropylene shell 8mm

### PADDING Injection molded polyurethane foam

Seat: thickness 20 mm, density 50 Kg/m<sup>3</sup>

Backrest: thickness 20 mm, density 50 Kg/m<sup>3</sup>

### LEGS / FRAME / BASE

11mm steel painted rod in aluminum, white, shadow grey or chrome

### UPHOLSTERY

categories B01-B03-C01-C05-W01-D02-P01 (SEE FABRIC FOLDER)

## DIMENSION

---

**chair**  
L 600 H 780 D 510

**seat**  
L 490 H 440 D 430

**backrest**  
L 400 H 340

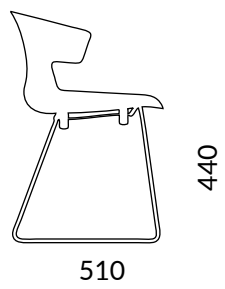
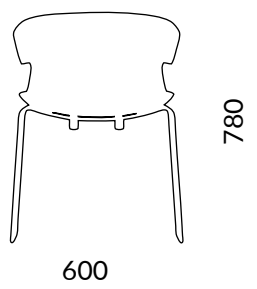

### WEIGHT

Net weight a chair: 6,5 Kg  
Gross weight a chair: 8,5 Kg

### PACKAGING

1 disassembled chair per box

### VOLUME x package

M3: 0,17

COD.OCOVEV22

TECHNICAL  
DATASHEET

Dimensions in millimeters





# COVE UPHOLSTERED WOODEN 4 LEG CHAIR

COD.OCOVEV23

## DESCRIPTION

Multifunctional chair with solid beech base and upholstered shell

## NOTE

11M fire retardant B01 fabric upholstered shell   
Personalized painted frame on request (min 20 pieces) 

## TECHNICAL INFORMATION

---

### STRUCTURE

Polypropylene seat

### PADDING Injection molded polyurethane foam

Seat: thickness 20 mm, density 50 Kg/m<sup>3</sup>

Backrest: thickness 20 mm, density 50 Kg/m<sup>3</sup>

### LEGS / FRAME / BASE

Solid beech with natural or wenghè finish. Personalized painted frame on request.

### UPHOLSTERY

categories B01-B03-C01-C05-W01-D02-P01 (SEE FABRIC FOLDER)

## DIMENSION

---

**chair**  
L 550 H 770 D 520

**seat**  
L 490 H 440 D 430

**backrest**  
L 400 H 340

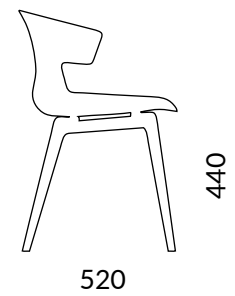
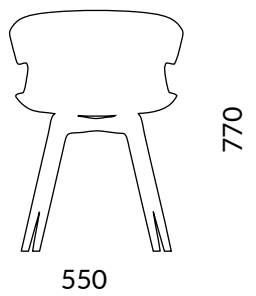

### WEIGHT

Net weight a chair: 5,5 Kg  
Gross weight a chair: 7,5 Kg

### PACKAGING

2 package with two shells  
1 package with two stems

### VOLUME x 2 chairs

M3: 0,41

COD.OCOVEV23

TECHNICAL  
DATASHEET

Dimensions in millimeters





# COVE UPHOLSTERED CHAIR WITH SWIVEL TRESTLE BASE

COD.OCOVEV24

## DESCRIPTION

Multifunctional chair with aluminum base and upholstered shell

## NOTE

11M fire retardant B01 fabric upholstered shell 

## TECHNICAL INFORMATION

---

### STRUCTURE

Upholstered polypropylene shell 8mm

### PADDING Injection molded polyurethane foam

Seat: thickness 20 mm, density 50 Kg/m<sup>3</sup>

Backrest: thickness 20 mm, density 50 Kg/m<sup>3</sup>

### LEGS / FRAME / BASE

700mm trestle in die-cast aluminum painted white, aluminum or shadow grey

### UPHOLSTERY

categories B01-B03-C01-C05-W01-D02-P01 (SEE FABRIC FOLDER)

## DIMENSION

---

**chair**  
L 560 H 780 D 510

**seat**  
L 490 H 440 D 430

**backrest**  
L 400 H 340

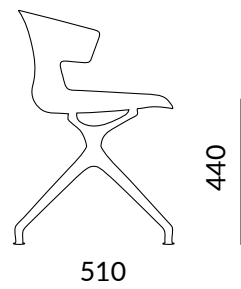
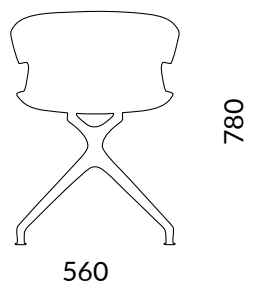

### WEIGHT

Net weight a chair: 7 Kg  
Gross weight a chair: 10 Kg

### PACKAGING

2 package with two shells  
1 package with two stems

### VOLUME x 2 chairs

M3: 0,39

COD.OCOVEV24

TECHNICAL  
DATASHEET

Dimensions in millimeters